



1. APPLICATIONS

Control panel for 1 motor at 230 or 120 Vac depending on version, with integrated radio receiver.

2. OPERATING INSTRUCTIONS

Operations are carried out via button P.ALT (15-16) or with transmitters.

Operations can be finished via any of the following: Activation by the corresponding the FC limit switch or by finalizing the working time.

If during opening, an order is given the operation will finish and the door will not close.

If during closing, an order is given the door will stop if another order is given the door will open.

Activation of C.SEG (13-14) during closing will open the door.

Activation of C.SEG1(12-13) during opening will stop the door (Option 3 OFF).

Activation of C.SEG1 (12-13) during opening and closing stops and inverts the door (Option 3 ON).

3. CONNECTIONS

3.1 CONTROL PANEL

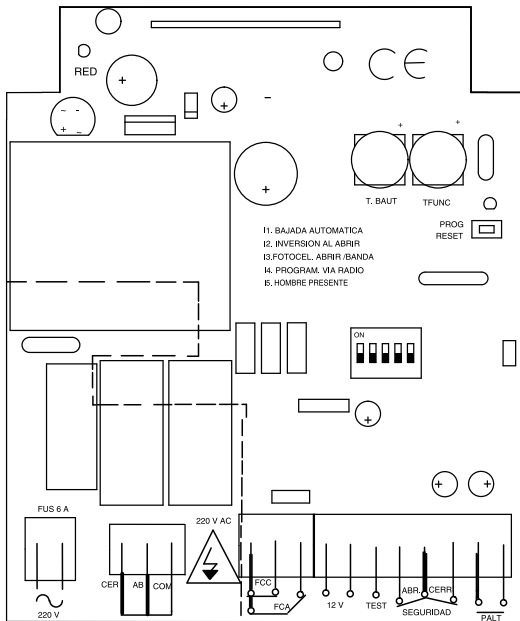

POWER SUPPLY

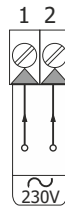

MONOPHASE MOTOR

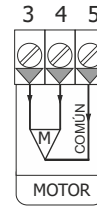

PUSH BUTTONS

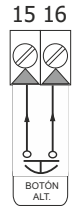

3.2 TERMINAL CONNECTIONS

DEAD MAN (OPTION 5 ON)

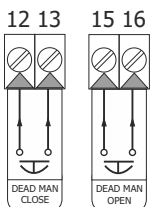

SAFETY EDGE (OPTION 3 ON)

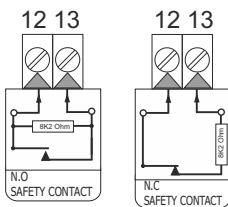

ACCESSORIES POWER SUPPLY

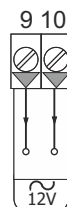

LIMIT SWITCHES

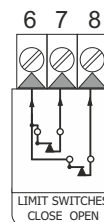

SAFETY

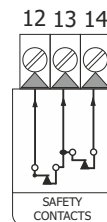

PHOTOCELL TEST

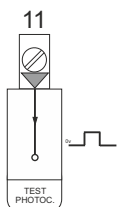

4. TIME REGULATIONS

AUTOMATIC CLOSING TIME



Regulates the waiting time before the automatic close
Turn LEFT to decrease and RIGHT to increase

Minimum - 5 sec
Maximum - 90 secs

WORKING TIME



Regulates the opening and closing time
Turn LEFT to decrease and RIGHT to increase

Minimum - 3 sec
Maximum - 90 secs

4. OPTIONS

1	AUTOMATIC CLOSING		- Door closes automatically after waiting a.c. time.
			- Door does not close automatically.
2	DISABLE STOP ON OPENING		- On opening the alternative button (15-16) is disabled.
			- On opening, if alternative button (15-16) is pressed, door stops.
3	PHOTOCELL 2 / SAFETY EDGE		- Input (12-13) works like 8k2 safety edge, stopping & reversing the maneuver in the opening and closing.
			- Input (12-13) works like safety photocell, stopping the maneuver in the opening.
4	RADIO FREQUENCY PROGRAMMING		- Allowed.
			- Not allowed.
5	DEAD MAN (see point 6.)		- DeadMan functionality enabled.
			- DeadMan functionality disabled.

6. DEADMAN

Dead man working conditions (Option 5 ON)

I5 = ON, In this case there will be no safety on automatic opening.

An open (N.O.) switch should be connected between CSEG1 & common CSEG which will serve as a closing switch.

I3 = ON Dead man will be activated on opening and closing.

I3 = Off Dead man will be activated only on closing.

7. PHOTOCELL TEST

At the beginning and end of each door operation the control panel tests the state of the photocells.

Once connected, the test function tests the cells 5 times (these 5 tests must be successful) to verify and memorize the connection. The control panel independently tests the two photocell inputs (CSEG & CSEG1). EG: We could have a photocell with test in input CSEG & bridge CSEG1. The control panel knows that there is a photocell with test CSEG and one without test on CSEG1. If a photocell connected to the test does not pass or fails, a RED LED FLASHES (programme indicator led), thus no automatic function will be allowed until a successful test has

8. TRANSMITTER MANUAL PROGRAMMATION

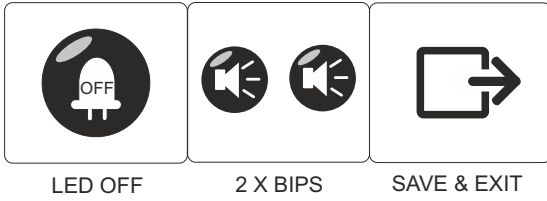
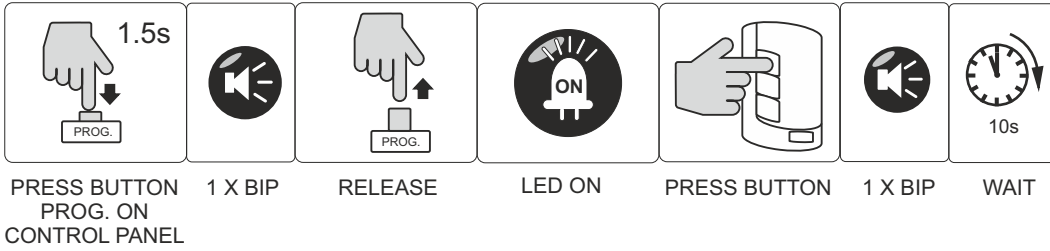

8.1 TRANSMITTER RADIO PROGRAMMING

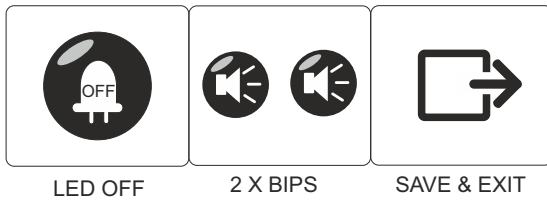
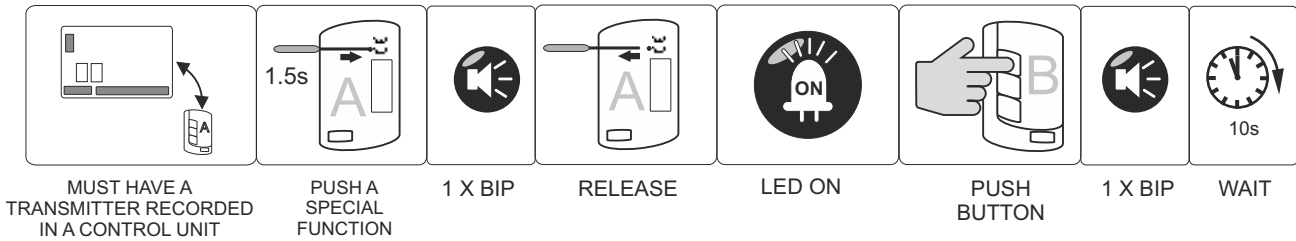

8.2 MEMORY RESET

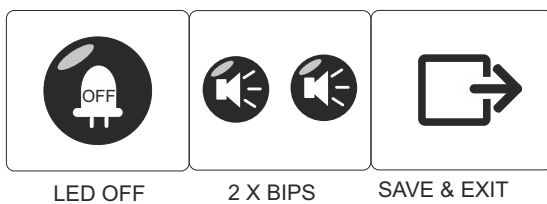
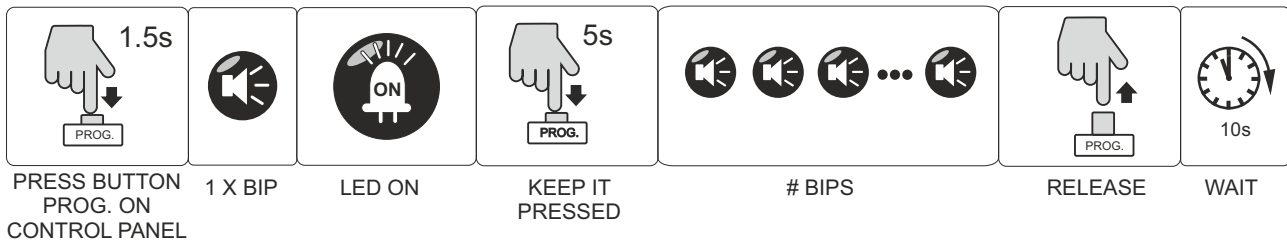

9. BOX HOUSING

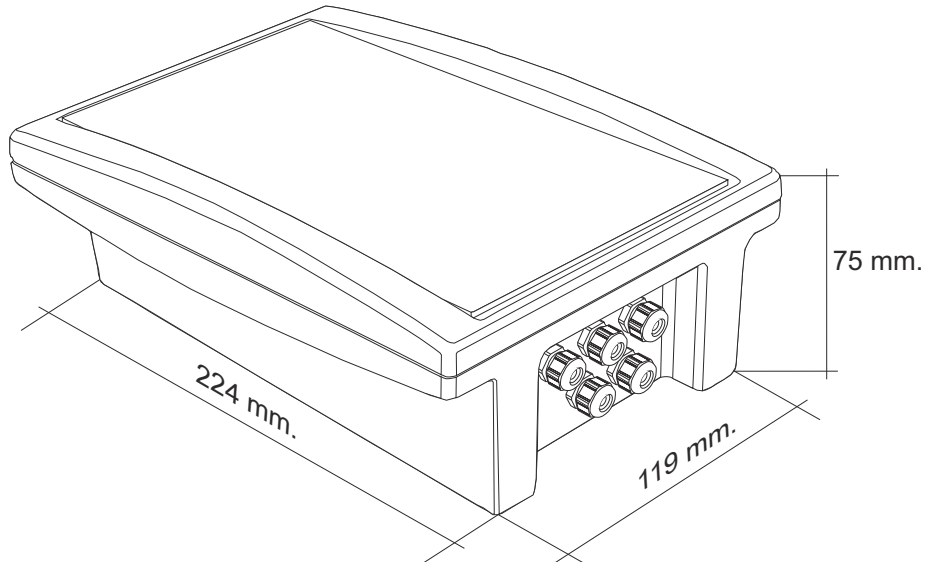

TECHNICAL SPECIFICATIONS

Power	230V AC +/- 10%
Max Drive Power	550W (0.74HP)
Power Supply for accessories	12V AC 125mA
Working Time	From 3 sec to 60 sec
Automatic closing time	From 5 sec to 90 sec
Code program	Self Learning
Frequency	433,92 or 868,35MHz
Distance	100m
Temperature	-20 to 85°
Sensitivity	Better that -100dBm

WARNING!!

- Equipment installation and start-up, can only be executed by qualified personal.

CE DECLARATION OF CONFORMITY
For more information visit the website www.aerf.eu

