



1. APLICATIONS

Control panel for 1 motor at 230. With force regulation, buffer stop at the end of each move.

2. OPERATING INSTRUCTIONS

The door operates via the alternative button (TEST / CI, Alternative button or by the radio card).

Door operation finishes by the following: by the corresponding limit switch(FC) of by finalizing the working time.

If an order is given during opening door will stop & the door will not close automatically.

If an order is given during closing door will open.

Activation of C.SEG during closing door will open.

The garage light comes on once the door begins to open and turns off 2 sec. after closing.

Pedestrian door button (20-21 N.O) opens for 16 sec. if activated.

3. CONNECTIONS

3.1 CONTROL PANEL

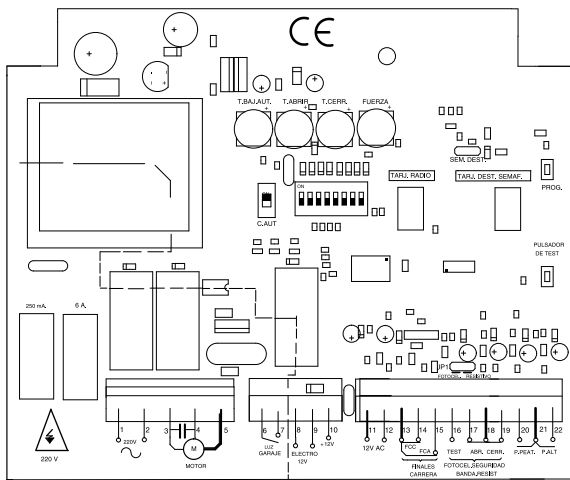

POWER SUPPLY

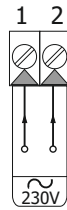

MONOPHASE MOTOR

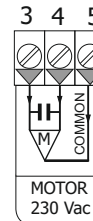

PUSH BUTTONS

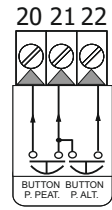

3.2 TERMINAL CONNECTIONS

GARAGE LIGHT

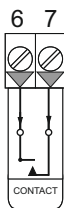

ELECTRIC LOCK

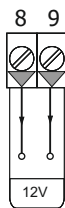

ACCESSORIES POWER SUPPLY

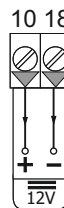
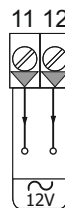

LIMIT SWITCHES

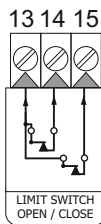

SAFETY

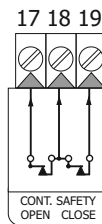

SAFETY EDGE (OPTION 5 ON)

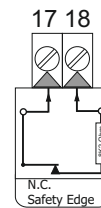
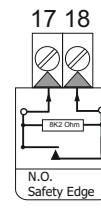

PHOTOCELL TEST

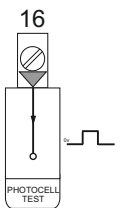

4. AUTOMATIC CLOSING OPTION

AUTOMATIC CLOSING

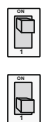

- Door closes automatically after waiting the a.c. time.
- Door does not close automatically.

5. BRIDGE SELECTORS

PHOTOCELL / RESISTIVE SAFETY EDGE



PHOTOCELL - Normally closed (e.g photocell)..



RESISTIVE SAFETY EDGE - Normally closed contact . 8K2 safety edge

TRAFFIC LIGHT / FLASHING LIGHT



TRAFFIC LIGHT - Green light is ON during automatic closing time. Before closing, the light will flash for 4 secs. The red light is ON during opening and closing.



FLASHING LIGHT - During the opening, flash relay output, is activated as fixed light. During the closing, it works intermittently (flash).

6. OPTIONS

1	DISABLE STOP ON OPENING		- In opening, the alternative button P.ALTS (21-22), transmitter and TEST are disabled.
			- The door can be stopped by TRANSMITTER, TEST, or P.ALTS (21-22).
2	INVERSION SHUT / STRIKE CLOSES		- Before opening the electrolock and closure relay are activated. By closing, the motor press for a moment.
			- Normally open with electro lock.
3	DOUBLE TIME		- Working time from 10 to 80 sec.
			- Working time from 5 to 40 sec.
4	CLOSE BY SAFETY CONTACT		- Door closes when is opened and C.SEG (18-19) is activated.
			- C.SEG (18-19) normally function.
5	PHOTOCELL 2 / SAFETY EDGE		- Input 17-18 (BAND) configured as resistive 8K2.
			- Input 17-18 (BAND) configured as mechanical N.C.
6	SOFT STOP		- Drive reduce its speed at the end of opening & closing. (see point 7. for soft stop programmation).
			- No soft stop.
7	HOURLY IMPULSE		- The door press 6 sec. every hour when closed & opened
			- Standard working conditions.
8	DIGITAL TIMING		- Digital times are memorized through programming button
			- Times are programmed through temporizers.

7. POTENTIOMETERS

AUTOMATIC CLOSING TIME (RED)



Regulates the waiting time before the automatic close Turn LEFT to decrease and RIGHT to increase.

Minimum - 5 sec
Maximum - 90 secs

OPENING TIME (WHITE)



Regulates the opening time Turn LEFT to decrease and RIGHT to increase

Minimum - 3 sec (10 sec if Option 3 is ON)
Maximum - 60 secs (80 sec if Option 3 is ON)

CLOSING TIME (GREEN)

* With option 6 & 8 ON, Buffer Closing speed regulation*



Regulates the closing time or Buffer closing speed. Turn LEFT to decrease and RIGHT to increase

Minimum - 3 sec (10 sec if Option 3 is ON)
Maximum - 60 secs (80 sec if Option 3 is ON)

DRIVE POWER (BLUE)



Regulates drive power Turn LEFT to decrease and RIGHT to increase

8. DIGITAL TIME PROGRAMMING (self-learning) (OPTION 8 ON)

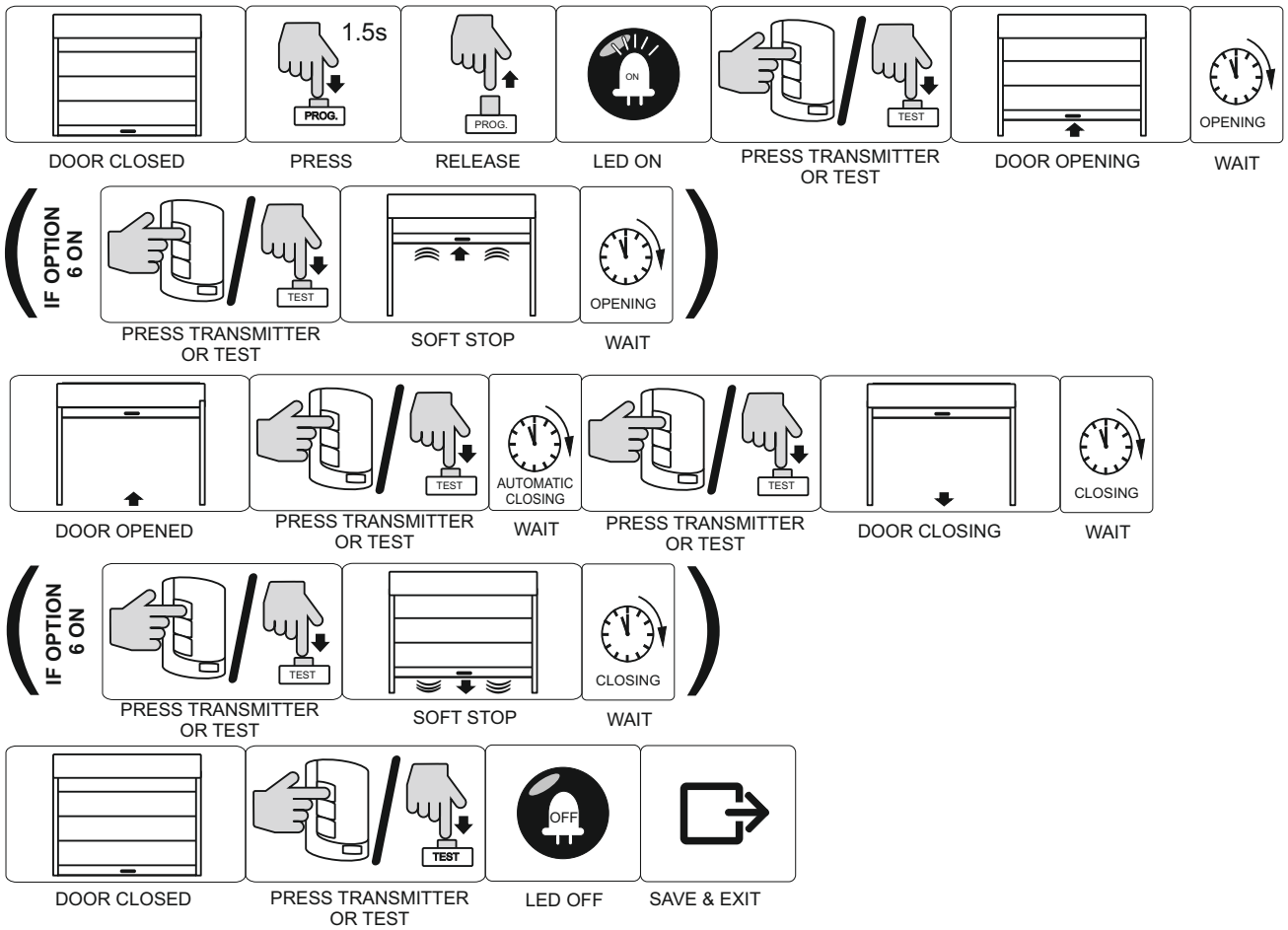

9. BOX HOUSING

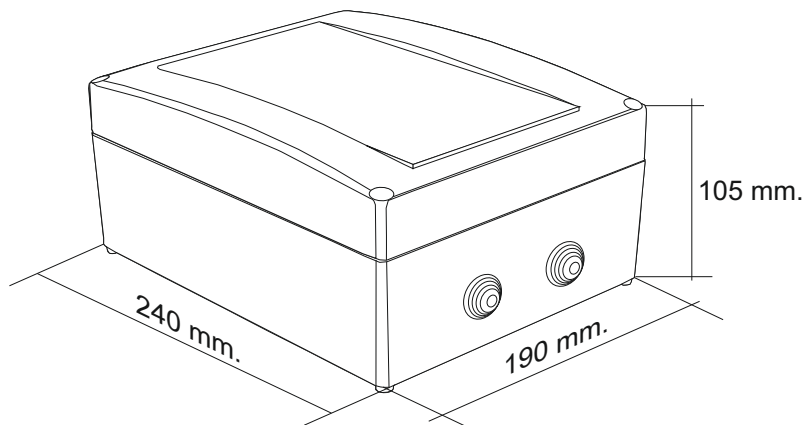

TECHNICAL SPECIFICATIONS

Power	230V AC +/- 10%
Max Drive Power	550 W (0.74 HP)
Power Supply for accessories	12V AC 200mA
Garage door output type	Power free contact
Electric lock	12V 1A.
Opening Time	From 3 sec to 40 sec (40 to 80 sec)
Closing Time	From 3 sec to 40 sec (40 to 80 sec)
Automatic closing time	From 5 sec to 110 sec
Temperature	-20 to 85°
Housing dimensions	170x140 mm

CE DECLARATION OF CONFORMITY
For more information visit the website www.aerf.eu

WARNING!!

- Equipment installation and start-up, can only be executed by qualified personal.

